

Tools Renewed Inc
Tel: 800-247-3639
Fax: 860-665-9821
Web: www.toolsrenewed.com

Spare parts list
Liste de pièces de rechange
Ersatzteilliste
Lista de piezas de repuesto
Lista de peças
Listino ricambi
Onderdelenlijst
Καταλογος ανταλλακτικῶν
Varaosu luettelo
Reservdelsliste
Reservdelfortegnelse
Reservdelsförteckning

**Pneumatic breakers
Brise-béton pneumatiques
Druckluft Aufbrechhämmer
Rompedores neumáticos
Martelos pneumáticos
Demolitori pneumatici
Pneumatische sloophammers
Κρουστικές μηχανές
Piikkausvasarat
Trykluftmejselhamre
Pneumatiske spett
Tryckluftspett**

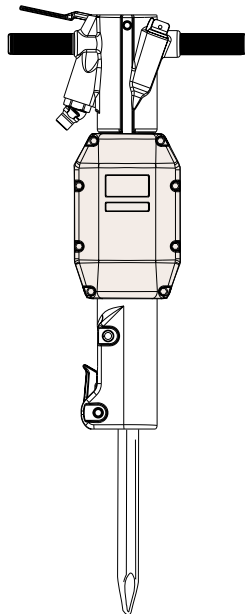

**TEX P60
TEX P60 S
TEX P90
TEX P90 S**

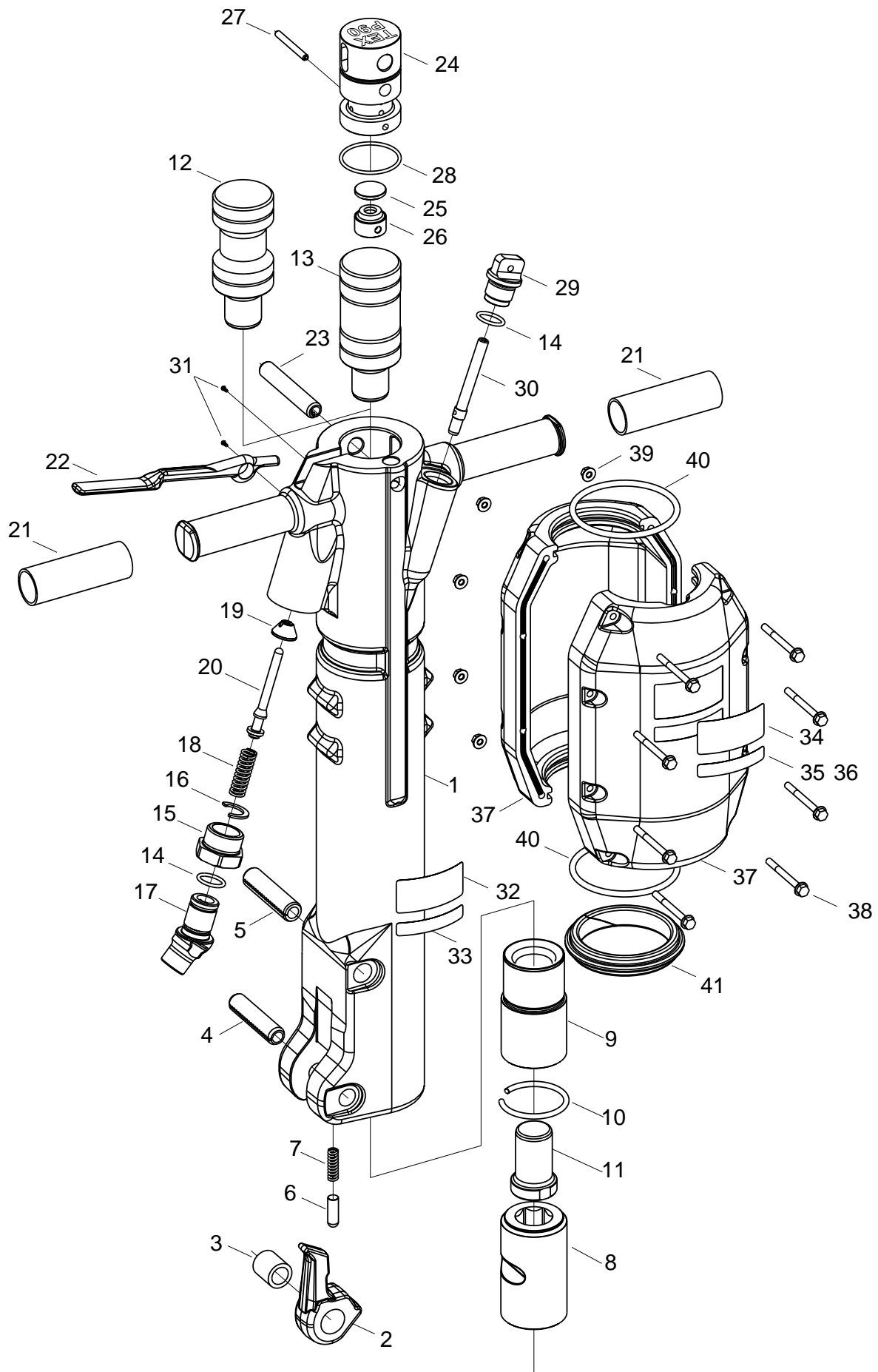

Fig. No. No. de fig. Abb. Nr. Núm de fig. Fig. No No rif. Fig. Nr Αριθ Σχ. Kuva nr. Fig. nr. Fig. nr. Fig. nr.	Ordering No Référence Bestellnummer Núm. pedido Encomenda No No Cat. Bestel nr. Αριθ. Παραγγελίας Tilaus nro. Bestillingsnummer Bestillingsnummer Best. nummer	Quantity Quantité Anzahl Cantidad Qvantidade Quantitá Aantal Ποσότητα Lukumäärä Antal Antal Antal				Description Description Beschreibung Descripción Descrição Descripción Omschrijving Περιγραφή Nimitys Beskrivelse Beskrivelse Beskrivning	Dimensions Dimensions Abmessungen Dimensiones Dimensões Dimensioni Afmetingen Διαστάσεις Mitat Dimensioner Dimensioner Dimensioner
		P60	P60 S	P90	P90 S		
1	3310 1269 00	1	1	-	-	Main body	
1	3310 1267 00	-	-	1	1	Main body	
	3310 0889 80	1	1	1	1	Tool retainer, compl	
2	—*)	1	1	1	1	- Tool retainer	
3	3310 0892 00	1	1	1	1	- Bushing	
4	0108 1691 06	1	1	1	1	Spring pin	Ø18x80 mm
5	0108 1691 54	1	1	1	1	Spring pin	Ø20x80 mm
6	3310 0893 00	1	1	1	1	Plunger	
7	3310 0894 00	1	1	1	1	Spring	
8	3310 1263 01	1	1	1	1	Tool bushing	28x160/152 mm
	3310 1263 00	1	1	1	1	Tool bushing	32x160/152 mm
9	3310 1264 00	1	1	1	1	Intermed. part	
10	3310 1053 00	1	1	1	1	Lock ring	
11	3310 1265 00	1	1	1	1	Anvil	
12	3310 1280 00	1	1	-	-	Piston	
13	3310 1266 00	-	-	1	1	Piston	
14	0663 2126 00	2	2	2	2	O-ring	Ø22.2x3.0 mm
15	3310 1044 00	1	1	1	1	Swivel nut	
16	3310 1059 00	1	1	1	1	Lock washer	
17	3310 1257 01	1	1	1	1	Swivel	3/4"
18	3310 1216 00	1	1	1	1	Spring	
19	3310 1211 00	1	1	1	1	Inlet valve	
20	3310 1258 00	1	1	1	1	Valve stem	
21	3310 1294 00	2	2	2	2	Sleeve	
22	3310 1251 00	1	1	1	1	Trigger	
23	0108 1691 55	1	1	1	1	Spring pin	Ø16x95 mm
24	3310 1256 01	-	-	1	1	Valve housing	
	3310 1256 00	1	1	-	-	Valve housing	
25	3310 1173 00	1	1	1	1	Main valve	
26	3310 1245 00	1	1	1	1	Valve cover	
27	0108 1335 00	1	1	1	1	Spring pin	Ø6x55 mm
28	0663 6134 00	1	1	1	1	O-ring	Ø49.5x3.0 mm
29	3310 0854 00	1	1	1	1	Oil plug	
30	3310 1260 00	1	1	1	1	Dosing feeder	
31	0244 4144 00	2	2	2	2	Screw	
32	0690 1101 03	1	-	1	-	Label	AC logo
33	3310 1290 00	1	-	-	-	Label	P60
	3310 1292 00	-	-	1	-	Label	P90
34	0690 1356 00	-	1	-	1	Label	AC logo
35	3310 1289 00	-	1	-	-	Label	P60 S

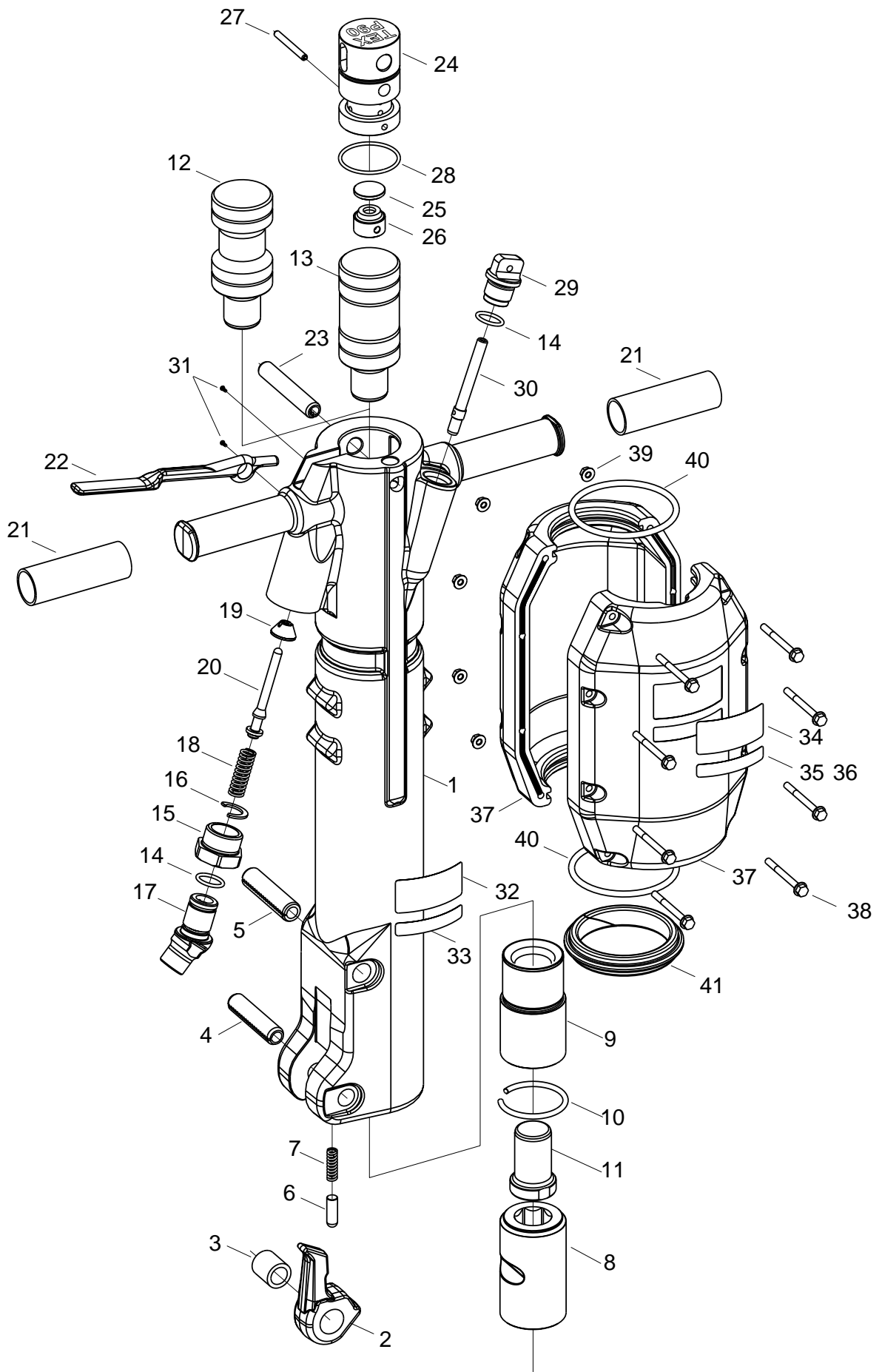

Fig. No.	Ordering No	Quantity	Description	Dimensions
No. de fig.	Référence	Quantité	Déscription	Dimensions
Abb. Nr.	Bestellnummer	Anzahl	Beschreibung	Abmessungen
Núm de fig.	Núm. pedido	Cantidad	Descripción	Dimensiones
Fig. No	Encomenda No	Quantidade	Descrição	Dimensões
No rif.	No Cat.	Quantità	Descrición	Dimensioni
Fig. Nr	Bestel nr.	Aantal	Omschrijving	Afmetingen
Αριθ Σχ.	Αριθ. Παραγγελίας	Ποσότητα	Περιγραφή	Διαστάσεις
Kuva nr.	Tilaus nro.	Lukumäärä	Nimitys	Mitat
Fig. nr.	Bestillingsnummer	Antal	Beskrivelse	Dimensioner
Fig. nr.	Bestillingsnummer	Antall	Beskrivelse	Dimensjoner
Fig. nr.	Best. nummer	Antal	Beskrivning	Dimensioner

		P60	P60 S	P90	P90 S		
36	3310 1291 00	-	-	-	1	Label	P90 S
	3310 1261 80	-	1	-	1	Silencer compl	
37	—*)	-	1	-	1	- Silencer	
38	0147 1976 06	-	8	-	8	- Flange screw	M6x62 mm
39	9232 0207 50	-	8	-	8	- Flange nut	M6 Triloc
40	0663 2146 00	-	1	-	2	O-ring	Ø94.1x5.7
41	3310 1262 00	-	1	-	-	Rubber bushing	

*) *Not delivered separately/ Non disponible en pièces de rechange/ Nicht separat lieferbar/ No se entrega como repuesto/ Non fornibile separatamente/ Não é vendido/ Niet afzonderlijk leverbaar/ Δεν παρέχεται ξεχωριστά/ Ei toimiteta erikseen/ Leveres ikke separat/ Leveres ikke som reservdel/ Levereras ej som reservdel*



Claw couplings

Part number	Description	Quantity	Dimensions
9000 0306 00	Claw coupling compl.	1	Standard 3/4"
9000 0000 00	- Seal	1	
9001 0005 06	Claw coupling compl.	1	US-universal 3/4"
9001 0005 15	- Seal	1	

AIR-OIL

Synthetic oil AIR-OIL/ Huile synthétique AIR-OIL/ Synthetisches Öl AIR-OIL/ Aceite sintético AIR-OIL/ Sintético óleo AIR-OIL/ Olio sintetico AIR-OIL/ Synthetische olie AIR-OIL/ **Συνθετικό λάδι** AIR-OIL/ Synteettinen öljy AIR-OIL/ Syntetisk olie AIR-OIL/ Syntetisk olje AIR-OIL/ Syntetisk olja AIR-OIL

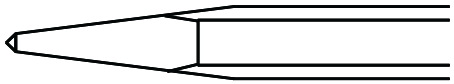
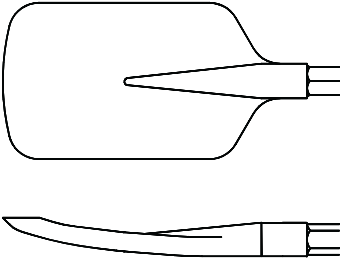
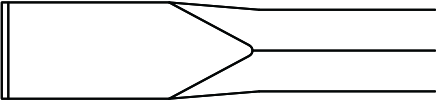
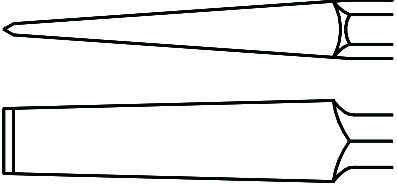
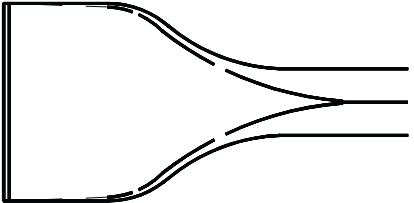
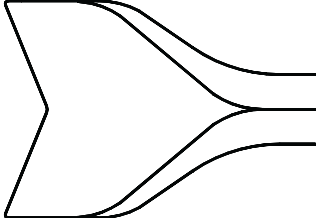
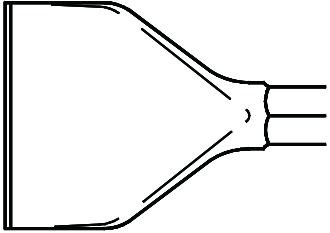
8099 0202 40	Air oil bottle	0.2 l
8099 0202 36	Air oil bottle	1 l
8099 0202 02	Air oil container	5 l
8099 0202 20	Air oil container	25 l
8099 0202 28	Air oil barrel	200 l

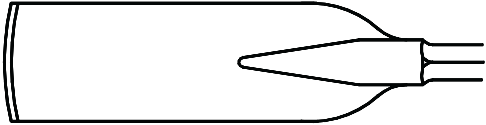
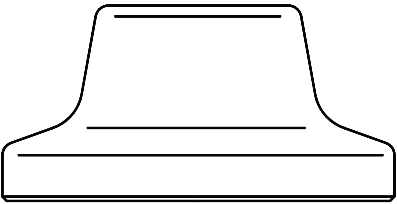
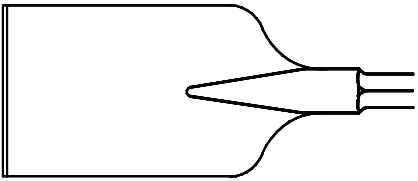
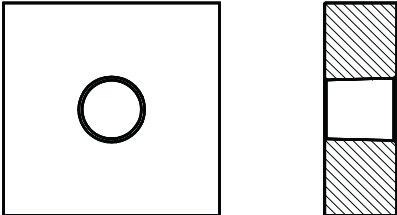
1		7	
2		8	
3		9	
4		10	
5		11	
6		12	

Tools H32x160, H28x160

Fig. No.	W = tip width mm	H32x160			H28x160		
	L = working length mm	W	L	Ordering No.	W	L	Ordering No.
1	Moil point	-	380	3083 3205 00	-	380	3083 3271 00
		-	450	3083 3206 00	-	450	3083 3272 00
		-	1000	3083 3207 00	-	1000	3083 3273 00
2	Narrow chisel	35	380	3083 3208 00	32	380	3083 3274 00
		35	450	3083 3209 00	32	450	3083 3275 00
		35	1000	3083 3210 00	32	1000	3083 3276 00
3	Wide chisel	75	380	3083 3211 00	75	380	3083 3277 00
4	Asphalt cutter	115	300	3083 3212 00	115	300	3083 3278 00
5	Digging chisel	75	380	3083 3213 00	75	380	3083 3279 00
6	Digging spade	125	380	3083 3214 00	125	380	3083 3280 00
7	Clay spade	140	380	3083 3215 00	140	380	3083 3281 00
8	Wedge chisel	40	400	3083 3216 00	40	400	3083 3282 00
9	Tie tamper	100	400	3083 3217 00			
		100	580	3083 3217 10			
10	Shaft for tamping pad	-	235	3083 3218 01	-	230	3083 3283 01
11	Tamping pad, round	180	-	3083 3301 00	180	-	3083 3301 00
12	Tamping pad, square	150	-	3083 3302 00	150	-	3083 3302 00
		200	-	3083 3197 00	200	-	3083 3197 00

Tools H32x152, H28x152

Fig. No.	W = tip width mm	H32x152			H28x152		
	L = working length mm	W	L	Ordering No.	W	L	Ordering No.
1	Moil point	-	380	3083 3285 00	-	350	3083 3267 00
2	Narrow chisel	35	380	3083 3286 00	32	350	3083 3268 00
3	Wide chisel	75	380	3083 3295 00	75	380	3083 3289 00
4	Asphalt cutter	125	330	3083 3296 00	125	330	3083 3290 00
5	Digging chisel	75	380	3083 3297 00	75	380	3083 3291 00
6	Digging spade	125	380	3083 3298 00	125	380	3083 3292 00
7	Clay spade	140	380	3083 3299 00	140	380	3083 3293 00
8	Wedge chisel	50	400	3083 3300 00	50	400	3083 3294 00
9	Tie tamper	100	400	3083 3314 00			
10	Shaft for tamping pad	-	230	3083 3287 00	-	230	3083 3269 00
11	Tamping pad, round	180	-	3083 3301 00	180	-	3083 3301 00
12	Tamping pad, square	150	-	3083 3302 00	150	-	3083 3302 00
		200	-	3083 3197 00	200	-	3083 3197 00